

Instruction manual

PM 945 • PM 946 • PM 929
RM 45 • RM 46 • RM 29

for version P2.00 to P2.49



Table of Contents

Brief Description	3
Use According to Stipulation	3
Safety Instructions	3
Notes to Operating Instructions	3
Installation	3
Scope of Delivery	4
Unpacking and Disposal	4
Mounting	5
Getting Started	5
Explanation and Correction of Errors	5
Error Report	5
Error Correction	6
Reload delivery state	6
Handling	6
Menu Structure	6
Setting the Limit Values - <i>SP 1 / SP2</i>	8
Setting the Hysteresis of Limit Values - <i>HY. 1 / HY.2</i>	8
Scaling of Display - <i>SCAL</i>	8
Setting the Zero Point Assignment - <i>nu1</i>	8
Setting the Full Scale Assignment - <i>FS</i>	8
Performing Calibration - <i>CAL</i>	9
Performing indirect Calibration - <i>ICAL</i>	9
.	9
Setting the scale - <i>SCL</i>	10
Setting the decimal point - <i>dP</i>	10
Assigning the Zero Value of Analog Output - <i>A.nu1</i>	10
Assigning the End Value of Analog Output - <i>A.FS</i>	10
Leaving the Sublevel of <i>SCAL</i> Menu - <i>EndE</i>	10
Setting Functions - <i>Func.</i>	11
Setting the Input Filter - <i>F ILT.</i>	11
Activating the Function of Control Input - <i>Ctrl</i>	11
Setting the Step Size / Rounding - <i>STEP</i>	12
Activating the Sign - <i>Sign</i>	12
Setting the Transmission Rate - <i>bAUD</i>	12
Setting the Transmission Protocol - <i>Prot</i>	12
Setting the communication address - <i>Adr.</i>	12

Setting Brightness of Display - <i>HEL</i>	12
Setting the Relay Function - <i>rEL.1 / rEL.2</i>	13
Leaving the Sublevel of <i>FUNC</i> Menu - <i>EndE</i>	13
System Settings - <i>SYS</i>	14
Balancing the Offset - <i>OFF</i>	14
Setting the Reference slope - <i>rEF</i>	14
Setting the Sensor Type - <i>LYP</i>	14
Setting the measurerate - <i>rATE</i>	14
Adjusting the Offset (Zero Position) of Analog Output - <i>R.OFF</i>	14
Adjusting the Reference Slope (Full Scale) of Analog Output - <i>R.rEF</i>	14
Leaving the Sublevel of <i>SYS</i> Menu - <i>EndE</i>	14
Determine the Safety Level - <i>CODE</i>	15
Saving the Settings - <i>SAVE</i>	15
Procedure for Adjusting Voltage, Current, DMS and Resistance Measurements	16
Aligning the Zero Point and Adjusting the Full Scale	16
Performing Calibration	17
Performing indirect Calibration	17
Cleaning and Maintenance	18
Disposal	18
Technical Data	18
Guarantee Service	18
Customer Service	18

Brief Description

The measuring instruments, digital panel meter and rail meter (termed instruments in the following), are provided for front panel mounting (panel meter) and rail mounting (rail meter). They are delivered with different measuring inputs:

PM945/ RM45 for current and voltage measurement

PM946/ RM46 for DMS or resistance measurement

PM929/ RM29 for temperature measurement



Note: For further information on the instruments refer to corresponding data sheet.

Use According to Stipulation

See also data sheet. The manufacturer is not liable for damages that arise from improper or regulation alien use.

Safety Instructions

Do not perform any high-handed modifications on instruments. Observe the relevant national safety regulations when installing the instrument.

Have non-functional instruments inspected by the manufacturer.

Notes to Operating Instructions



Notes give you information to which you shall pay attention to when operating the instrument.



Attention indicates that you must follow the given information, which serves, for your own safety or for safety reasons of the instrument. Disregard can lead to injuries or to damage of the instrument.

Installation



Attention: Only qualified personnel familiar with relevant national electrical engineering safety regulations may install instruments.

Scope of Delivery

The scope of delivery includes:

- Instrument
- Respective data sheet for each instrument
- Adhesive strips for the display unit (dimension), for the functions of control input and for the limits values that are located on the upper or bottom side of the instrument.
- for /F, /J and /H will be delivered with protocol description "serial interfaces".

Delivery of panel meter includes:

- Screw clips (clamping devices) located on side of instrument (see data sheet)
- 10-pin removable screw clamp connector, and
- for /R and /K options an additional 5-pin removable screw clamp connector is supplied

Delivery of rail meter includes:

- 15-pole removable screw clamp connector

Unpacking and Disposal

Take the enclosed parts from the packaging and check parts for completeness. Contact the customer service if the delivery is incomplete.

- ! Attention: Dispose of the packing material in the corresponding containers for cardboard/ paper and synthetic material.

Mounting

The **rail meter** is to be snapped onto the rail. The appropriate adhesive strips are to be adhered as described for the panel meter.

Prior to mounting the **panel meter** into the switch panel, adhere the labels to the panel meter as follows:

Adhere the labels (see section Scope of Delivery) onto the proper luminous fields that are on the right side of display. To do this, remove the frame from the front panel or the entire front screen by grasping the lower carving. Cut and peel off labels on adhesive strip as needed, for example, V for the display value and adhere onto rectangular luminous field. Then label, for example, "hold" for the function of control input (see section Activating the Control Input Function) and adhere onto bottom rectangular field. Adhere labels "SP1" and if necessary "SP2" for the limits (see section Setting the Limit) onto the top luminous fields.



Note: Adhere SP2 label to the top most luminous field.

To mount the panel meter into the switch panel, cut out an opening on the panel according to the drawing on data sheet. Remove the screw clips from the instrument and slide the instrument into the cutout. Then reattach the screws and fasten the instrument with the screws to the switch panel. Screwdriver can be used to tighten screw clips.



Note: Screw clamp assignments for the connections, for example supply voltage, are shown on data sheet.



Attention: When applying the supply voltage, take into account the operating data given on the type label on the topside of instrument.

Getting Started

Settings are not necessary to get started. If the standard settings are insufficient for the respective applications, the instrument's settings need to be adapted.

After switching on or after applying the supply voltage, the system runs a self-test. Should errors be detected, they will be shown on the display. The error and supplementary numbers appear in succession. After 10 seconds, a self-test is repeated.

Explanation and Correction of Errors

Error Report

Error codes have the following meaning:

Err.0	EPROM defective or not correctly readable
Err. 1	EEPROM defective or check sum is incorrect
[Err	Incorrect input of codes for the safety level or at calibration (see sections Determine the Safety Level resp. Performing Calibration)

Error Correction

When error $Err. 0$ is displayed continuously, the instrument has to be taken out of service and sent back to the manufacturer.

When error $Err. 1$ is displayed, the data integrity can be recovered by reloading the delivery state (see section Reloading the Delivery State). Should the recovery of the delivery state fail, the instrument must be sent back to manufacturer.

Note: The turn/press switch must be pressed and held up to 10 seconds in order to move from the error $Err. 1$ to the service mode and with that into the menu system.

Reload delivery state

Prior to this, * 12049 must be entered in the menu $CODE$ to change to the service mode in order to load the delivery state with the entry of * 32 10 (display: $In It$). Subsequently, then save in the menu $SAVE$ so that the delivery state is loaded.

Handling

1. Remove the small cap on front screen to gain access to the turn/push switch (switch) to perform settings.
2. Use small insulated screwdriver to carry out settings.
3. Press the switch using the screwdriver to call up the first menu; turn the switch to run through the menus (see section Menu Structure)
4. Press the switch to activate the currently displayed menu and the first menu item will appear.
5. Turn or press the switch once again to carry out the settings in the individual menu items.
6. The display flashes and can be changed by turning.
7. Numeric settings such as limit values are carried out dynamically, that is, the quicker the turning the larger the numeric steps.
8. Press switch again to confirm the input numbers, thereafter the next menu item of the activated menu appears.
9. **The settings are stored only after calling up the menu $SAVE$ and pressing the switch.**
10. If the switch is not actuated within 10 seconds, the menu will break off and the instrument will reset if necessary and restart with old values.



Attention: If the instrument is opened, conducting parts that lie on the electrical potential of the measuring input are accessible and can be touched. If the settings are carried out with non-insulated screwdriver, the conducting parts that lie on the electrical potential of the measuring input can also be touched.

Menu Structure



The instrument has several safety levels that are activated with corresponding codes. Only those menu items are displayed that are enabled for the set safety level.



Note: The delivery state is the service mode.

Service Mode

Note: The menus *SP 1/SP 1'*, *SP2/SP2'* and *HY 1/HY2* are only active, if corresponding relay functions have been set.

- Legend:**
-  Press the turn/press switch with screwdriver
 -  Turn the turn/press switch with screwdriver

 Only these menus and menu items are activated in normal mode

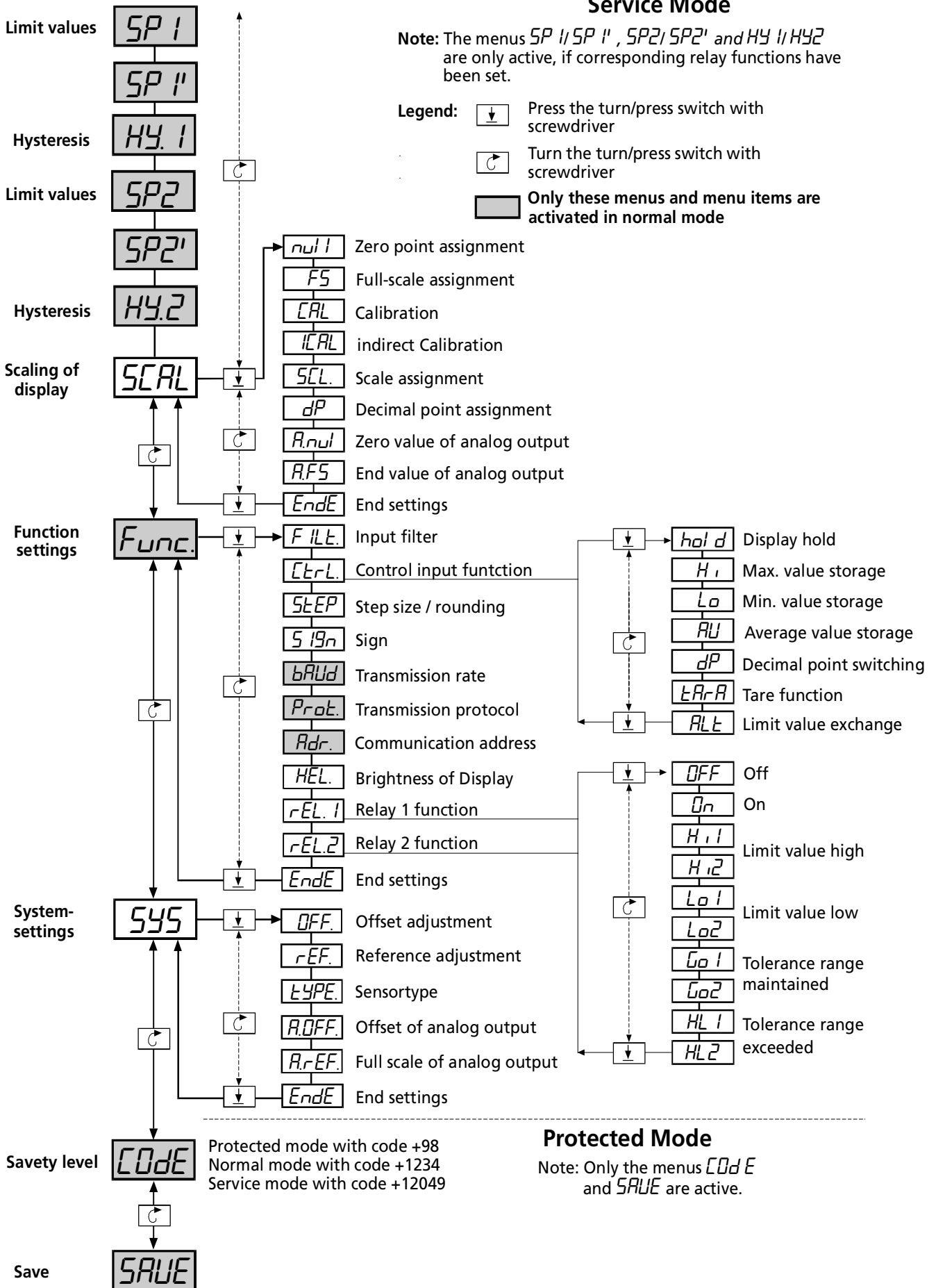

Setting the Limit Values - *SP 1 / SP2*

In this menu, the corresponding limit values (break over points) can be set. When the tolerance range monitoring is activated, corresponding limit value pairs are made available, during which the upper and lower limit values are assigned automatically (see section Setting the Relay Function).

Note: The menu *SP 1 / SP2* is displayed only if the functions, limit high and limit low, were set in advance in the menu *Func* at *rEL. 1* or *rEL.2* and the protected mode is not activated. To represent the switch point of the limit value on the display, the corresponding label should be adhered to corresponding luminous field as described in section Installation.

Setting the Hysteresis of Limit Values - *HY. 1 / HY.2*

In this menu, the default value of the switching hysteresis for the corresponding limit value or limit value pairs can be set. Only positive values are possible. For a failure-free limit monitoring, the value shall never be greater than the measuring range or half of the tolerance range (see Setting the Relay Function)

 Note: The menu *HY. 1 / HY.2* is displayed only if the functions, limit high and limit low, were set in advance in the menu *Func* at *rEL. 1* or *rEL.2* and the protected mode is not activated.

Scaling of Display - *SCAL*

Setting the Zero Point Assignment - *nu1*

The display value can be set at measuring input 0.

 Hint: use *CAL*

Setting the Full Scale Assignment - *F5*

The display value can be set at end scale value (+19999)

Hint: use *CAL*

Performing Calibration - \overline{CAL}

While calibrating the instrument, set the currently displayed value the same as for the zero and full-scale values. In this case, the calibration is for the latest measured value and not for the zero and full scale.

1. Apply the first calibration value.
2. Then call up the menu item \overline{CAL} and the external measured value will appear on the display.
3. Set the display value to the desired value and confirm by pressing the switch.
4. \overline{CAL}^2 will appear on the display automatically.
5. Apply the second calibration value that will appear on the display after pressing the switch.
6. Set the display value to the desired value and confirm by pressing the switch.

The instrument automatically calculates from this data the zero and full-scale value.



Note: To archive a high accuracy, calibration values should be chosen so that they are placed possibly wide apart. If they are too close or cause an opposite sign, the calibration will be canceled and \overline{Err} is displayed for one second.

Performing indirect Calibration - \overline{ICAL}

This has the same effect as the calibration, but you have to enter the measure values.

1. Call up the menu item \overline{ICAL} and after short display of \overline{InP}^1 the first input value will appear on the display.
2. Set the display value to the desired value and confirm by pressing the switch.
3. \overline{dSP}^1 will appear awhile and then the first display value.
4. Set the first display value to the desired value corresponding to the first input value and confirm by pressing the switch.
5. \overline{InP}^2 appears awhile and after set the second input value and confirm.
6. After \overline{dSP}^2 appears set the second display value and confirm again.

The instrument automatically calculates from this data the zero and full-scale value.



Note: To archive a high accuracy, calibration values should be chosen so that they are placed possibly wide apart. If they are too close or cause an opposite sign, the calibration will be canceled and \overline{Err} is displayed for one second.

Setting the scale - *SCAL*.

When measuring voltage, current, DMS, and resistance, it is possible to set 1-, 2-, 4-, 8-, 16-, 32-, 64- or 128-fold amplification for the scale factor.

When measuring temperatures, the scale can be changed to degrees $^{\circ}C$, degrees $^{\circ}F$ or Kelvin (*Ab5*).

Setting the decimal point - *dP*

The decimal point can be set for the currently active decimal point level (see section Determining the Control Input Function).

Assigning the Zero Value of Analog Output - *Anul*

The display value can be set at the analog output that is to output its minimum value.

Assigning the End Value of Analog Output - *AFS*

The display value can be set at the analog output that is to output its maximum value.

Leaving the Sublevel of *SCAL* Menu - *EndE*

Execute *EndE* to leave the sublevel for settings and to return to menu *SCAL* starting position.

Setting Functions - F_{UNC} .

Setting the Input Filter - F_{ILT} .

For the display to show stable values when the measured values are fluctuating, an average of 1 to 127 measurements can be set. This does not have an effect on the measuring rate or display rate of instrument except that the setting time is changed. For negative values, the filter has a jump function enabling the display to instantly follow the measured values when they are rapidly changing.

Activating the Function of Control Input - $Ctrl$

Following functions are available for the control input:

- Display Hold - $hold$
When the function $hold$ is activated, the currently displayed value freezes. The measuring, limit monitoring and interface communication (not with BCD) still continue.
- Maximum Value Storage - H_1
When the function H_1 is activated (edge triggering), the statistic storage (min/max/average) is erased. As long as H_1 is active, the maximum value is displayed.
- Minimum Value Storage - L_0
When the function L_0 is activated (edge triggering), the statistic storage (min/max/average) is erased. As long as L_0 is active, the minimum value is displayed.
- Average Value Storage - AV
When the function AV is activated (edge triggering), the statistic storage (min/max/average) is erased. As long as AV is active, the average value is displayed.
- Decimal Point Switching - dP
When the function dP is activated (edge triggering), the decimal point switches to the second decimal point level, making it possible to change the decimal point position when switching over to a different measuring point.
- Tare Function - $TARA$
When the feature $TARA$ is activated (edge triggering), the currently display value is zeroed, that means the currently attached measuring value is gauged for zero. As long as the control line is active, the tared value is output.
- Limit Value Exchange - ALT
When the function ALT is activated, the limit values are switched around during limit range monitoring. That is, if for example relay 1 was configured to the first limit value H_{i1} (see section Setting the Relay Function) it responds to the second limit value H_{i2} while the control input is active.



Note: The lower luminous field on the display shows the status of control line. By adhering the corresponding label (see section Installation), the active function can be represented on the display (min/max/av/tara/Alt).

Following labels are supplied: Ctrl, Hold, Min, Max, Av, Tara and Alt.



Note: The delivery state for the function of control line is display hold.

Setting the Step Size / Rounding - *STEP*

The last position of the display value can be set to steps of 1, 2, 5 or 10 so that the rounding of the last position with steps of 2 are 0, 2, 4, 6 and 8, with steps of 5 are 0 and 5, and with steps of 10 is 0.

Activating the Sign - *Sign*

Which sign (+, -, or +-) is to be represented can be set. If for example the plus sign (+) is disabled, plus sign is not displayed with positive values, however the minus sign (-) is still displayed with negative values.

Setting the Transmission Rate - *BAUD*

The transmission rate for the serial port can be set to 300, 600, 1200, 2400, 4800, 9600, 19200, or 57600 bits per second (baud).

 Note: The delivery state for the transmission rate is 9600 baud.

Setting the Transmission Protocol - *Prot*

The most used transmission protocols with 7 or 8 data bits and none (*n*), even (*E*) and odd (*O*) parity and 1 or 2 stop bits for the serial interface can be set.

Representation Example: *7.E.1*

 Note: The delivery state is 7 data bits, even parity (E) and 1 stop bit.

Setting the communication address - *Adr.*

The address for the serial interface at which the instrument is to be addressed can be set. The address 0 disables the addressing of the serial interface, or when a fieldbus is integrated only broadcast messages are processed.

 Note: The delivery state for the address is 0.

 Note: Changes to settings for *BAUD*, *Prot*, or *Adr* come into effect only after reset is carried out and have no effect on the BCD bus or if there is no serial interface. A reset is triggered by interrupting the supply voltage until the display is dark and reconnecting the supply voltage or switching on again.

Setting Brightness of Display - *HEL*.

The brightness of display can be changed in the range from 0 = very light to 5 = very dark.

 Note: The delivery state for the brightness is 2.

Setting the Relay Function - *rEL. 1 / rEL.2*

Functions for the response of the relay can be set as follows:

- OFF
The corresponding relay is always passive
- ON
The corresponding relay is always active when the instrument is on and ready for service.
- Exceeding the High Limit Value - *H. 1 / H.2*
Whenever the set limit value is reached, the relay switches to its active state. The first or second limit value can be set. The relay returns to rest position only after the measured value falls below the high limit value and the amount of the hysteresis.
- Exceeding the Low Limit Value - *Lo. 1 / Lo.2*
Whenever the set limit value is reached, the relay switches to its active state. The first or second limit value can be set. The relay returns to rest position only after the measured value has risen above the low limit value and the amount of the hysteresis.
- Maintaining the Tolerance Range - *Go. 1 / Go.2*
As long as the measured value remains within the set limits (tolerance range), the relay is in its active state. The hysteresis is also active here.
- Exceeding the Tolerance Range - *HL. 1 / HL.2*
As long as the measured value remains within the set limits (tolerance range), the relay is passive. When the set limits are reached and exceeded, the relay switches to its active state. The hysteresis is also active here.



Note: Only with the tolerance range monitoring are limit value pairs made available.

Leaving the Sublevel of *FUNC* Menu - *EndE*

Execute *EndE* to leave the sublevel for settings and to return to menu *FUNC* starting position.

System Settings - *SYS*

Balancing the Offset - *OFF*

The offset of amplifiers or sensors can be balanced. The latest scaled measured value will be displayed and the offset can be adjusted. The slope remains unchanged.

Setting the Reference slope - *rEF*

By displaying the latest scaled measured value, it is possible to adjust the reference of A/D converter (slope) and/or the amplification of amplifiers or external sensors.

 Note: The offset remains unchanged and therefore has to be adjusted in advance.

Setting the Sensor Type - *LYP*

When measuring voltage, current, DMS or resistance, it is possible to select the measuring range.

On temperature measuring with thermocouple the sensor type can be set.

Following settings for sensors are possible: type J (*J*), K (*H*), S (*S*), R (*r*) or C (*L*).

Setting the measurerate - *rAEE*

The measure rate of the meter can be selected in conversions per second.

 Note: At rates above 16 the specification of the datasheet can be exceeded.

Adjusting the Offset (Zero Position) of Analog Output - *A.OFF*

The offset of analog output can be adjusted. The output quantity changes during the adjustment. Therefore, it is necessary to monitor the output quantity with measuring instrument.

Adjusting the Reference Slope (Full Scale) of Analog Output - *A.rEF*

Full scale output of the analog output can be set similarly to the offset (*A.OFF*).

 Note: The offset output setting remains unchanged and has to be adjusted in advance.

Leaving the Sublevel of *SYS* Menu - *EndE*

Execute *EndE* to leave the sublevel for settings and to return to menu *SYS* starting position

Determine the Safety Level - *CODE*

Entering the desired code (see Menu Flow Chart) changes the mode accordingly. If an invalid code is entered, *Err* is displayed for one second. The menu *CODE* is shown again on the display.



Note: The delivery state is the service mode.

Saving the Settings - *SAVE*

Only after selecting this menu, will the settings be permanently stored in the internal EEPROM. The instrument indicates the successful saving by a brief interruption of the display and subsequently leaves the menu *SAVE*.



Attention: Don't interrupt the power during saving process, otherwise, the loss of data (*Err. !*) could occur.

Procedure for Adjusting Voltage, Current, DMS and Resistance Measurements

Aligning the Zero Point and Adjusting the Full Scale

1. Remove either the front frame with the red filter or plug cap on the front screen to gain access to the turn/push switch for adjustments.

! Attention: While the instrument is open, conducting parts that lie on the electrical potential of the measuring output can be accessible or could be touched with the non-isolated!

2. Apply the supply voltage to the instrument.
3. Press the switch once using a small insulated screwdriver and turn clockwise until the menu *SCAL* appears. Pressing the switch again makes the menu item *0* appear on the menu *SCAL*. After pressing the switch, the current display value for the measuring input value 0 appears. Turning the switch can change this value. Once the desired value is set, pressing the switch will confirm and display menu item *0*. Turning the switch will call up the menu item *FS* and, as described before, make the settings for the full scale value of measuring range. If the values for the measuring input 0 or the full scale value for measuring are not given, they can be calculated with the following formula:

DV1 = display at measurement value 1 (MV1)

DV2 = display at measurement value 2 (MV2)

X = 0 for *0* value, or 19999 as measurement range full scale (*FS*)

$$\frac{(DV2 - DV1) \cdot (X - MV1)}{(MV2 - MV1)} + DV1 = \text{value to be set}$$

4. Call up the menu item *dP* and by turning and then turning the switch set the position of the decimal point.
5. After completing the settings, turn the switch to the menu item *End E* and end the menu *SCAL* by pressing the switch. Turn the switch to call up the menu *SAVE* and press the switch to save the settings permanently. The instrument returns to the measuring mode.

Performing Calibration

1. Remove either the front frame with the red filter or remove the plug cap on the front screen to gain access to the turn/push switch for the adjustments.
2. Connect the supply voltage to the instrument and connect with an external source (calibrator or sensor). Then apply the first calibration value to the instrument.
3. Press the switch using a small isolated screwdriver and turn clockwise until the menu *SCAL* appears on the display. Pressing the switch again using the screwdriver will call up the first menu item *inP1* on the menu *SCAL*. Then keep turning until the menu item *CAL* appears. Pressing the switch again will make the momentary applied first calibration value appear and by turning can be changed to desired value. Pressing the switch will confirm this display value and make the menu item *CAL2* appear. Then apply a second calibration value to the instrument and make the setting for the second calibration as described before.
4. Call up the menu item *dP* and by turning and then turning the switch set the position of the decimal point.
5. After completing the settings, turn the switch to the menu item *End E* and end the menu *SCAL* by pressing the switch. Turn the switch to call up the menu *SAVE* and press the switch to save the settings permanently. The instrument returns to the measuring mode.

Performing indirect Calibration

1. Same as 1 above, than connect the supply voltage to the instrument.
2. Press the switch using a small isolated screwdriver and turn clockwise until the menu *SCAL* appears on the display. Pressing the switch again using the screwdriver will call up the first menu item *inP1* on the menu *SCAL*. Then keep turning until the menu item *ICAL* appears. Pressing the switch again will display *inP1* awhile followed by the first input value. By turning it can be changed to desired value. Pressing the switch will confirm this display value and make the menu item *dSP1* appear awhile followed by the first display value. Adjust the value corresponding to the first input value and press the switch to confirm. Do the same for the second input *inP2* and the corresponding display value *dSP2*.
4. Call up the menu item *dP* and by turning and then turning the switch set the position of the decimal point.
5. After completing the settings, turn the switch to the menu item *End E* and end the menu *SCAL* by pressing the switch. Turn the switch to call up the menu *SAVE* and press the switch to save the settings permanently. The instrument returns to the measuring mode.

Example: A strain sensor is specified with 1,985 mV/V at 15 t load, after assembly the instrument shows 1015 counts at no weight load. For the first value *inP1* the the display value of 1015 must be applied, on *dSP1* the corresponding display value of 0. On *inP2* a calculated value at 15 t load must be applied (here 1,985 mV/V x 5 V strain supply + offset of 1015 = 10940 μ V) and at *dSP1* 15000 for 15,000 t. The position of the decimal point can adjusted under menu *dP*.

Cleaning and Maintenance

The instrument is maintenance-free. Clean the instrument with soft damp cloth.



Note: Do not use any aggressive liquids such as solvents. Type of materials used for case and front panel can be obtained from the data sheet.

Disposal

Observe the latest valid legal regulations for hazardous waste when disposing of instruments.

Technical Data

Technical data can be obtained from the data sheet.

Guarantee Service

Defects that occur within one year as of delivery will be repaired free of charge if the instrument is sent to the manufacture at own cost.

Customer Service

Brose Systeme GmbH

Kienitzer Str. 98
12049 Berlin

Tel: +49 (0)30 / 62 70 91 93
Fax +49 (0)30 / 62 70 91 95

<http://www.brose-systeme.de>
e-mail: service@brose-systeme.de